

DESIGN Ferruccio Laviani – 2019



Scrivanie. I piani e le gambe sono realizzati con pannelli di nobilitato (per la versione in cuoio o pelle) o di particelle di legno (per la versione impiallacciata). Elemento frontale disponibile anche in marmo New Saint Laurent; altri marmi disponibili su richiesta.

Cassettiera e allungo. Struttura realizzata in pannello di particelle di legno impiallacciato o in pannello nobilitato rivestito in cuoio o pelle. Piedini sempre impiallacciati. Frontali di ante e cassetti disponibili rivestiti in cuoio o in pelle o impiallacciati nelle essenze disponibili di serie. Maniglie disponibili in cuoio o pelle o in acciaio verniciato color titanio.

Mobili. Struttura in nobilitato nero. Piedini, base e fianco destro sempre impiallacciati. Top e fianco sinistro disponibili impiallacciati o rivestiti in cuoio o pelle. Frontali di ante e cassetti disponibili rivestiti in cuoio o in pelle o impiallacciati nelle essenze disponibili di serie. Cassetti in multistrato laccati neri. Maniglie disponibili in cuoio o pelle o in acciaio verniciato color titanio.

Cuoio e pelle. Le cuciture sono disponibili solamente nella versione in cuoio; nella versione in pelle non sono disponibili. In base alla categoria di cuoio scelta, la misura dei diversi "tagli" dello stesso può variare in maniera sensibile.

Essenze disponibili di serie: Ebano Macassar, Noce canaletto fiammato tinto grigio. Altre finiture disponibili solo su richiesta.

Desks. The tops and legs are made with melamine coated panels (for the saddle leather or leather version) or particleboard panels (for the veneered version). Front element also available in New Saint Laurent marble; other marbles available on request.

Pedestal and return cabinet. Frame made in particleboard panel veneered or in melamine coated panel covered in saddle leather or leather. Feet always veneered. Fronts of doors and drawers available covered in saddle leather or leather or veneered in the standard woods available. Handles available in saddle leather or leather or in titanium color painted steel.

Cabinets. Frame made in melamine coated panel. Feet, base and right side panel always veneered. Top and left panel available veneered or covered in saddle leather or leather. Fronts of doors and drawers available covered in saddle leather or leather or

veneered in the standard woods available. Drawer's frame in black lacquered plywood. Handles available in saddle leather or leather or in titanium color painted steel.

Saddle leather and leather. The stitchings are available only in the saddle leather version; in the soft leather version they are not available. Depending on the category of saddle leather chosen, the size of its different "cuts" can vary significantly.

Standard wood veneers available: Macassar Ebony wood, Veined black walnut wood grey stained. Other finishes available only on request.

SCRIVANIE – DESKS

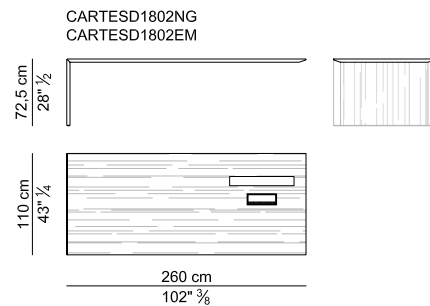
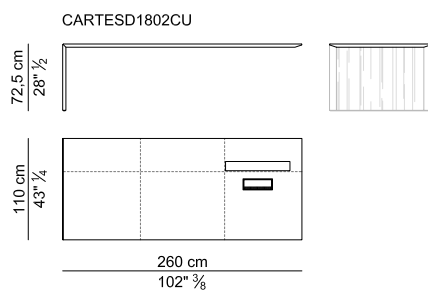
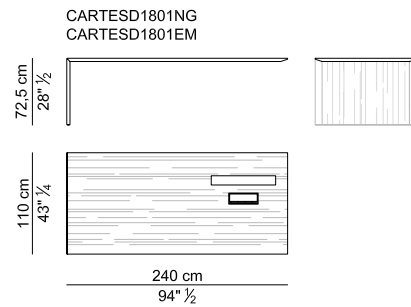
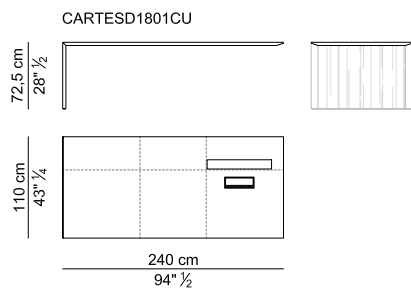
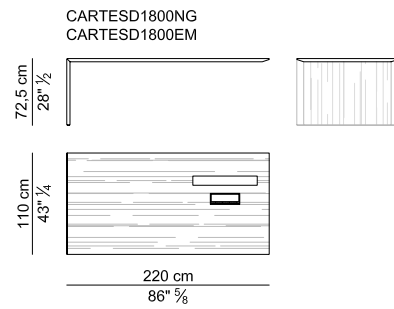
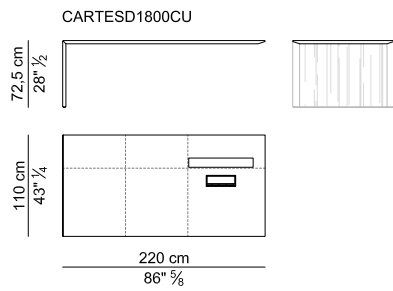

SOTTOMANO – WRITING PAD

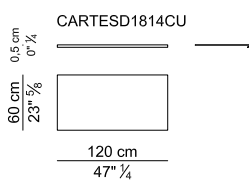

ELEMENTI FRONTALI PER SCRIVANIA – FRONT ELEMENT FOR DESKS

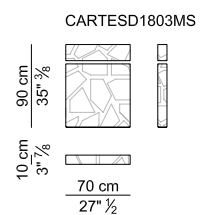
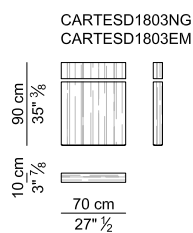
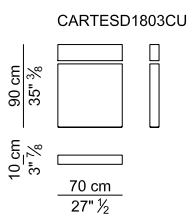

PANNELLI DI CORTESIA – MODESTY PANELS

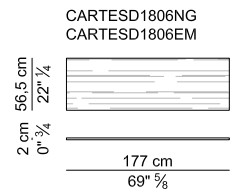
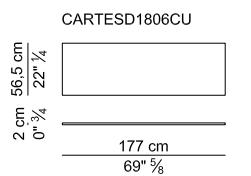
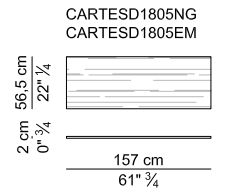
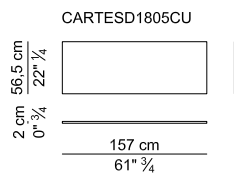
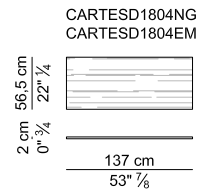
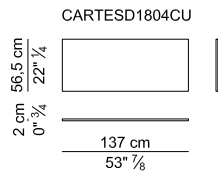

CASSETTIERE FISSE – FIXED PEDESTALS

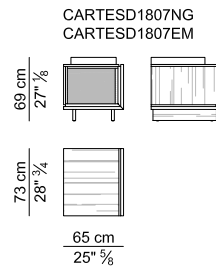
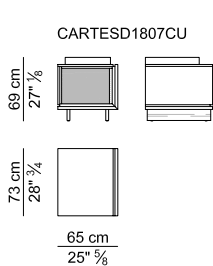

CASSETTI PER CASSETTIERE FISSE – DRAWERS FOR FIXED PEDESTALS

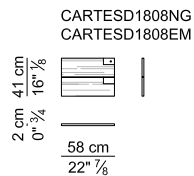
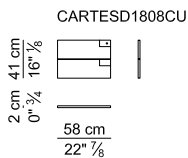

MOBILI ALLUNGO – SIDEBORD CABINETS

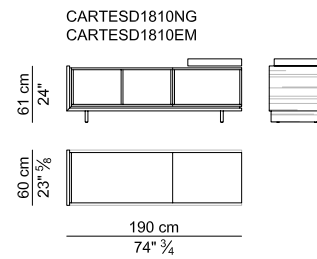
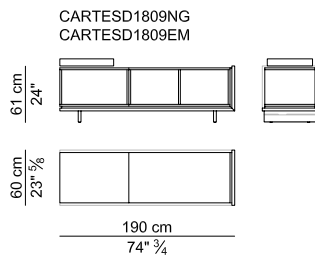

TOP PER MOBILE ALLUNGO – TOP FOR SIDEBORD CABINET

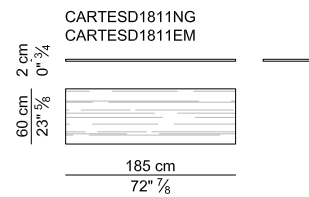
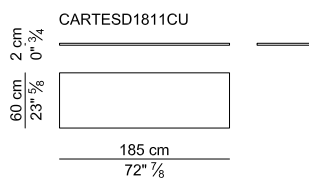

ANTE E CASSETTI PER MOBILE ALLUNGO – DOORS AND DRAWERS FOR SIDEBORD CABINET

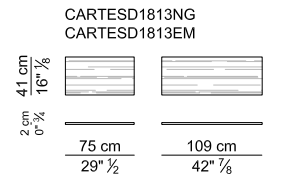
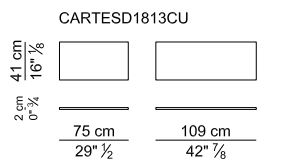
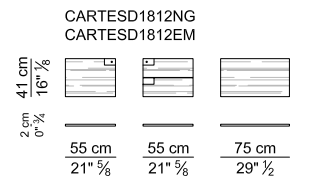
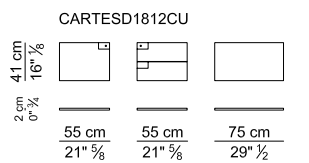

MOBILI BASSI – LOW CABINETS

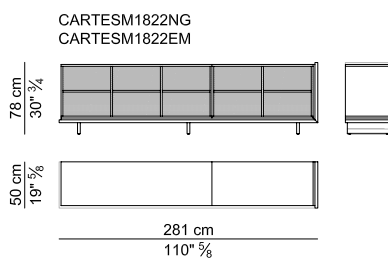
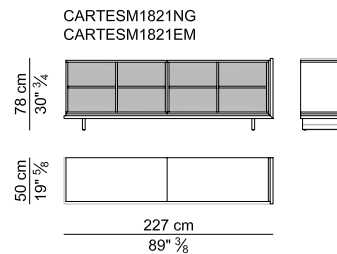
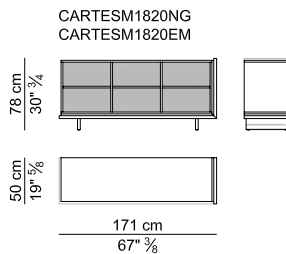

TOP E FIANCO SINISTRO PER MOBILE BASSO – TOP AND LEFTSIDE PANEL FOR LOW CABINET

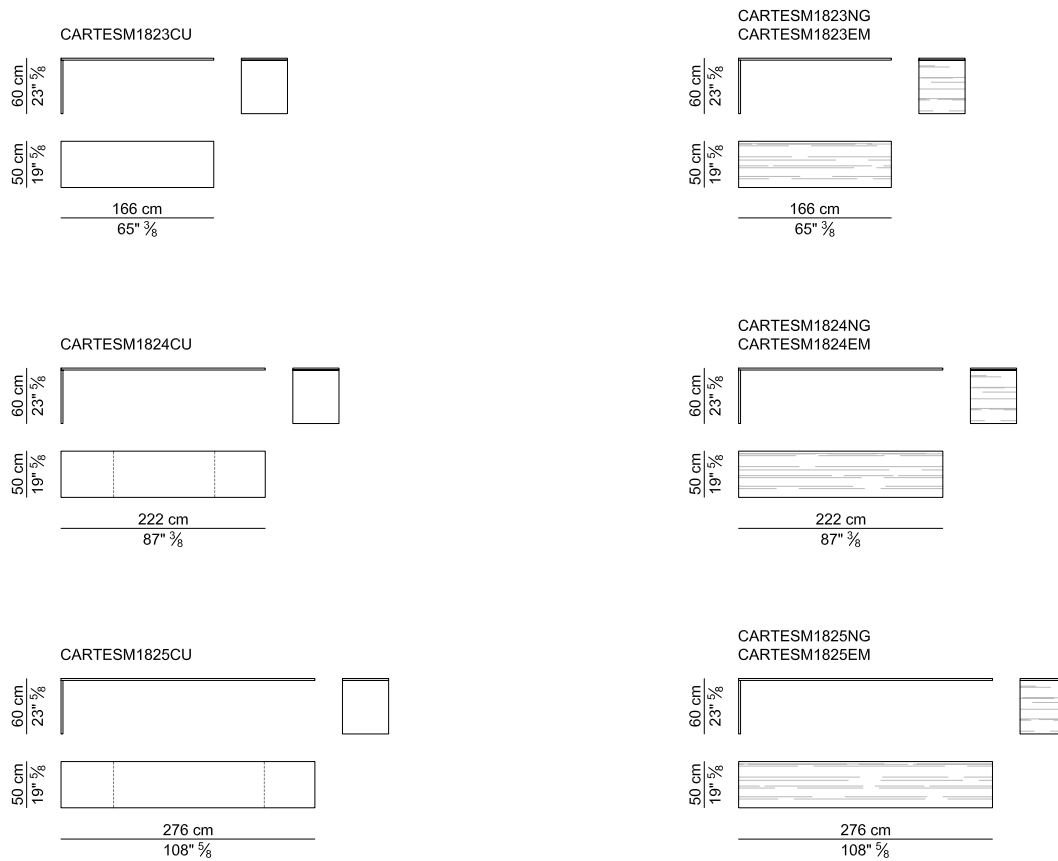

CASSETTI E ANTE PER MOBILE BASSO – DRAWERS AND DOORS FOR LOW CABINET

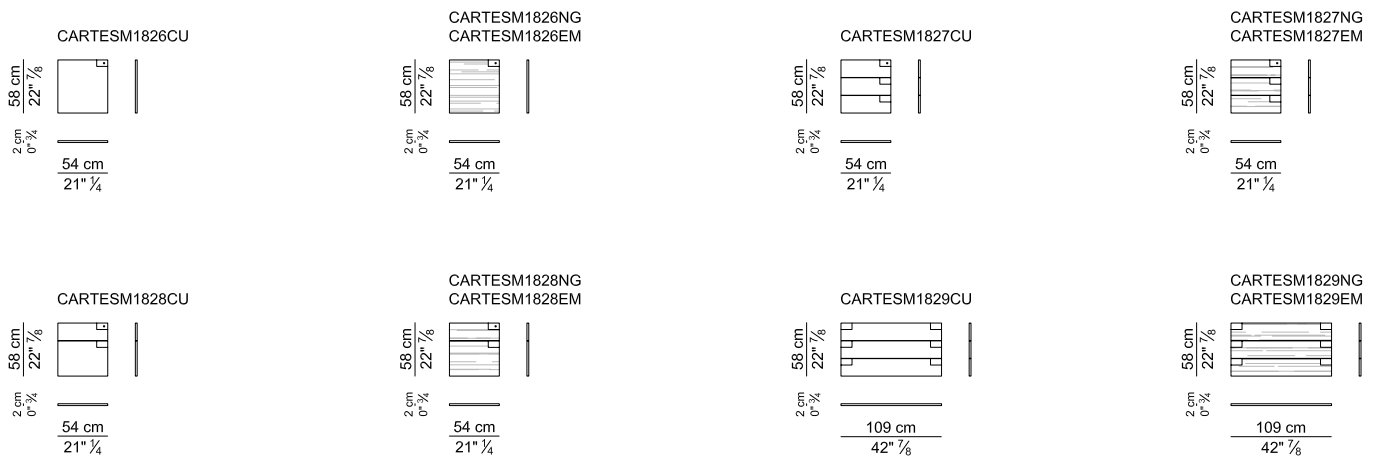

MOBILI INTERMEDI – MEDIUM CABINETS

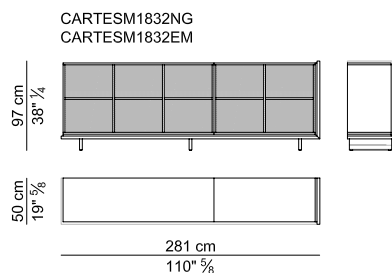
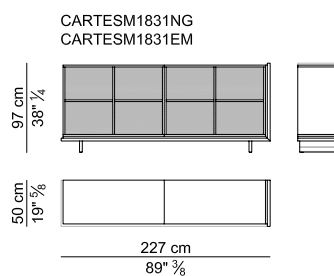
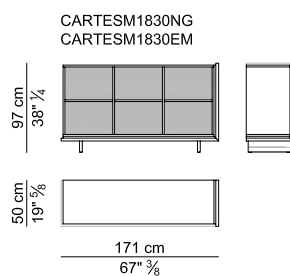

TOP E FIANCO SINISTRO PER MOBILE INTERMEDIO – TOP AND LEFTSIDE PANEL FOR MEDIUM CABINET

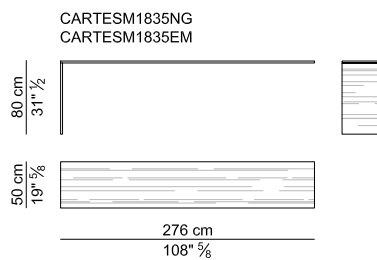
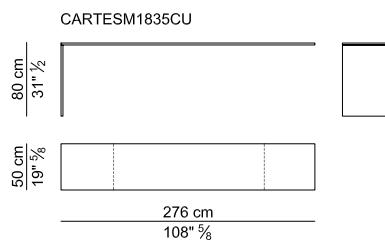
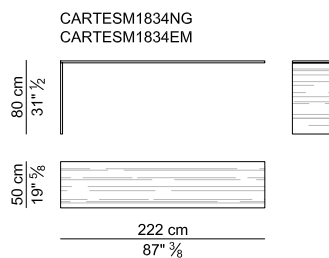
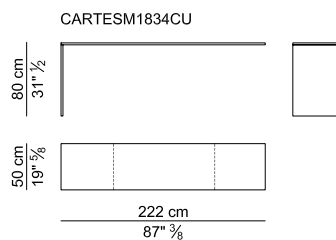
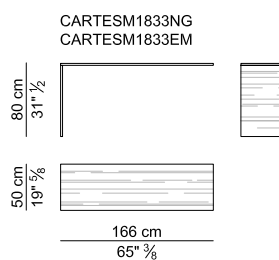
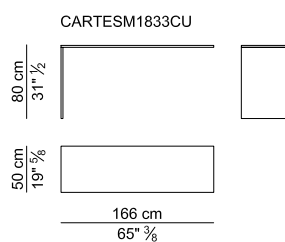

CASSETTI E ANTE PER MOBILE INTERMEDIO – DRAWERS AND DOORS FOR MEDIUM CABINET

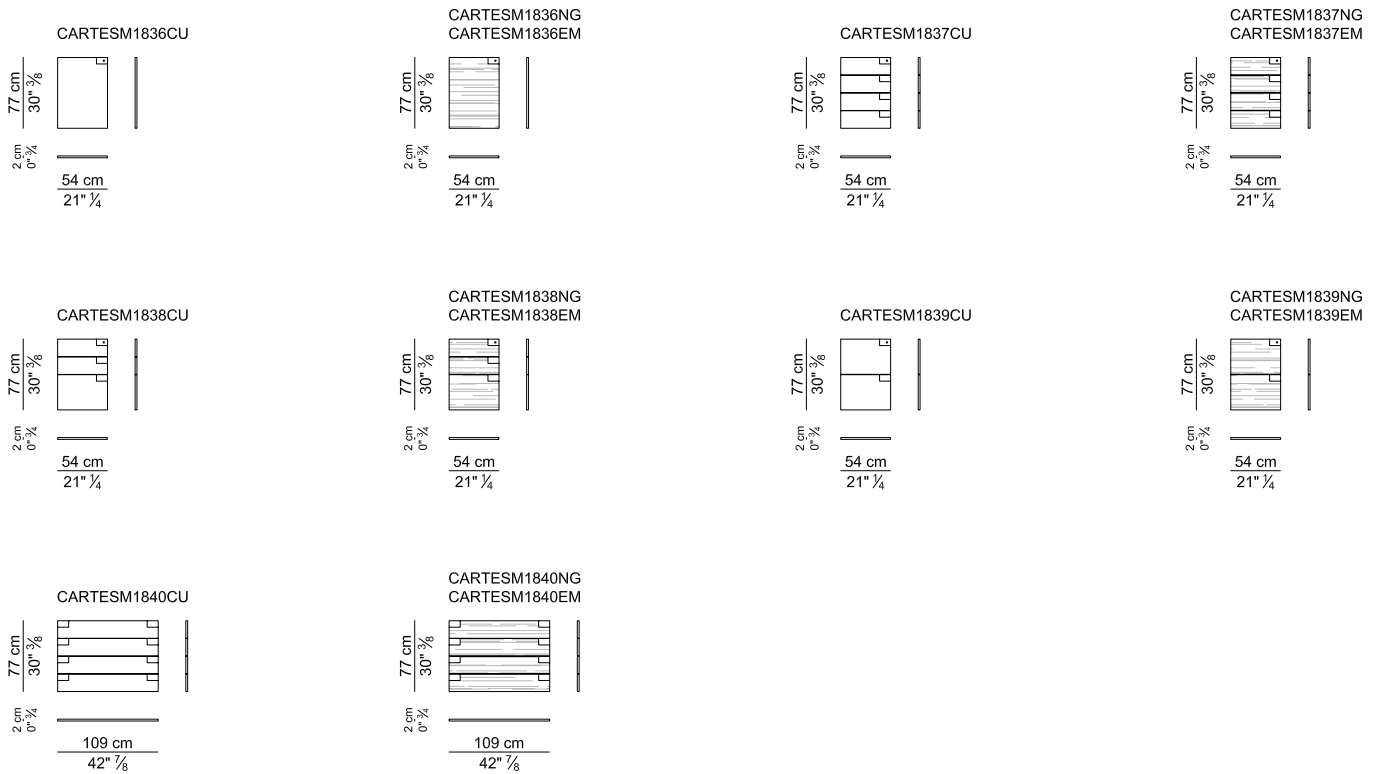

MOBILI ALTI CM. 196 – 196 CM. HIGH CABINETS



TOP E FIANCO SINISTRO PER MOBILE ALTO CM. 196 – TOP AND LEFTSIDE PANEL FOR 196 CM HIGH CABINET

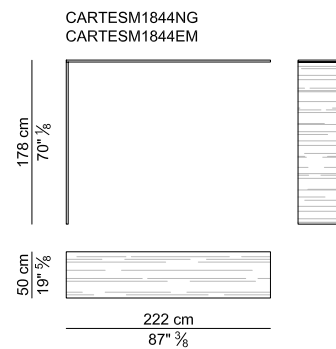
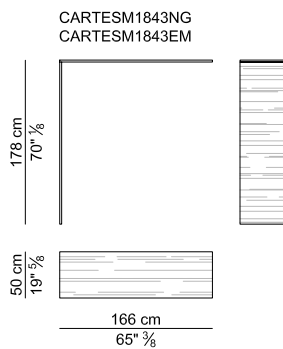
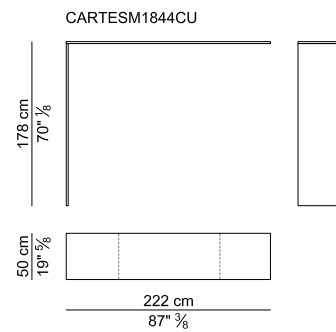
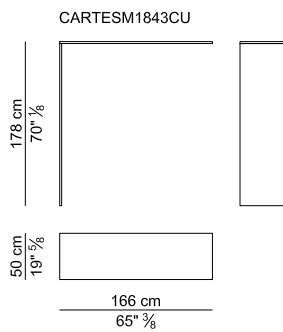

CASSETTI E ANTE PER MOBILE ALTO CM. 196 – DRAWERS AND DOORS FOR 196 CM. HIGH CABINET

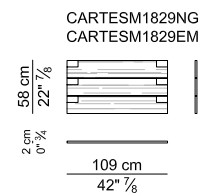
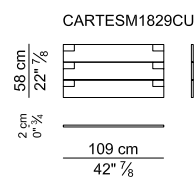
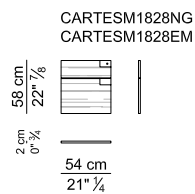
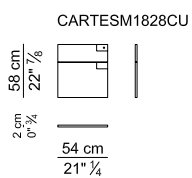
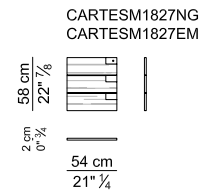
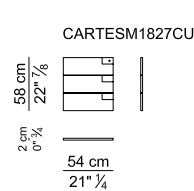
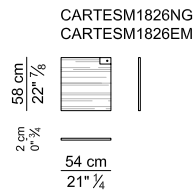
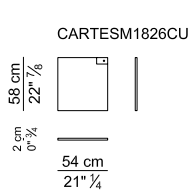

MOBILI ALTI CM. 215 – 215 CM. HIGH CABINETS

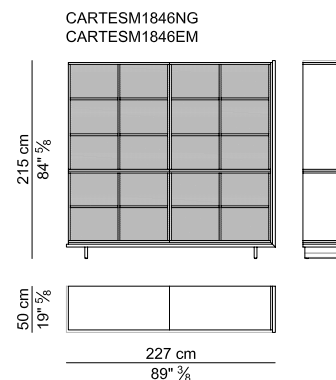
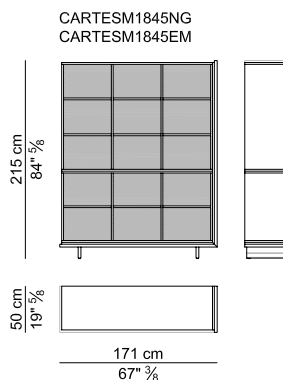

TOP E FIANCO SINISTRO PER MOBILE ALTO CM. 215 – TOP AND LEFTSIDE PANEL FOR 215 CM HIGH CABINET

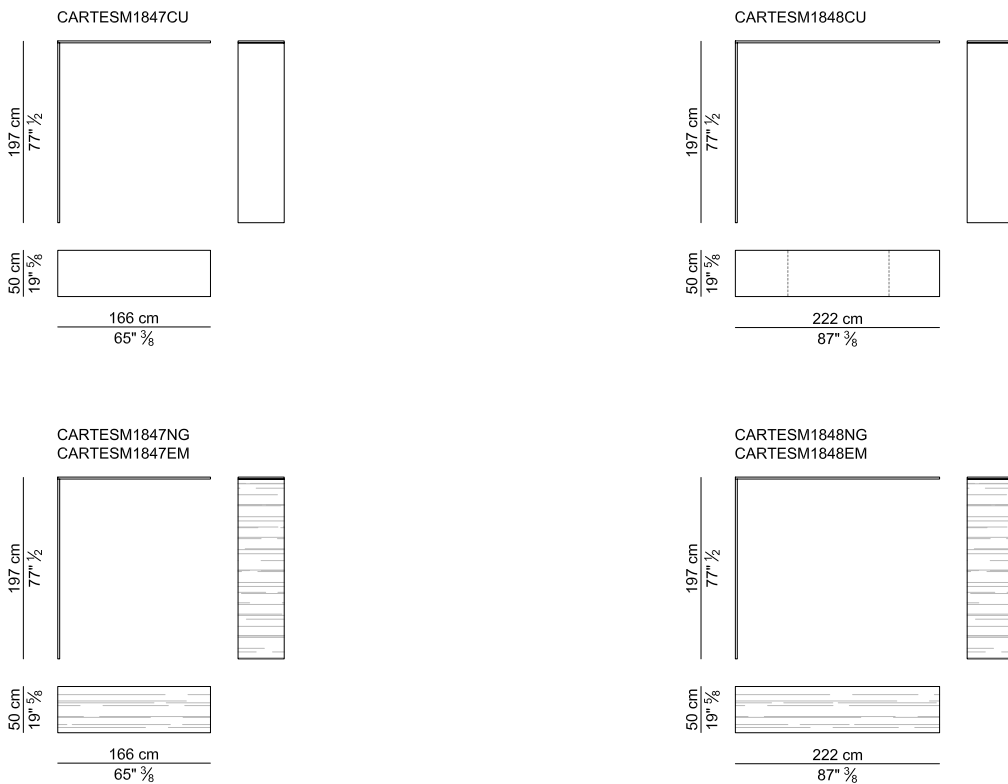

CASSETTI E ANTE PER MOBILE ALTO CM. 215 – DRAWERS AND DOORS FOR 215 CM. HIGH CABINET

